

Article number: 435700011

Description: Rota-fix shaft-hub connection K 11x22

Note: Self centering. Medium torque

Measures

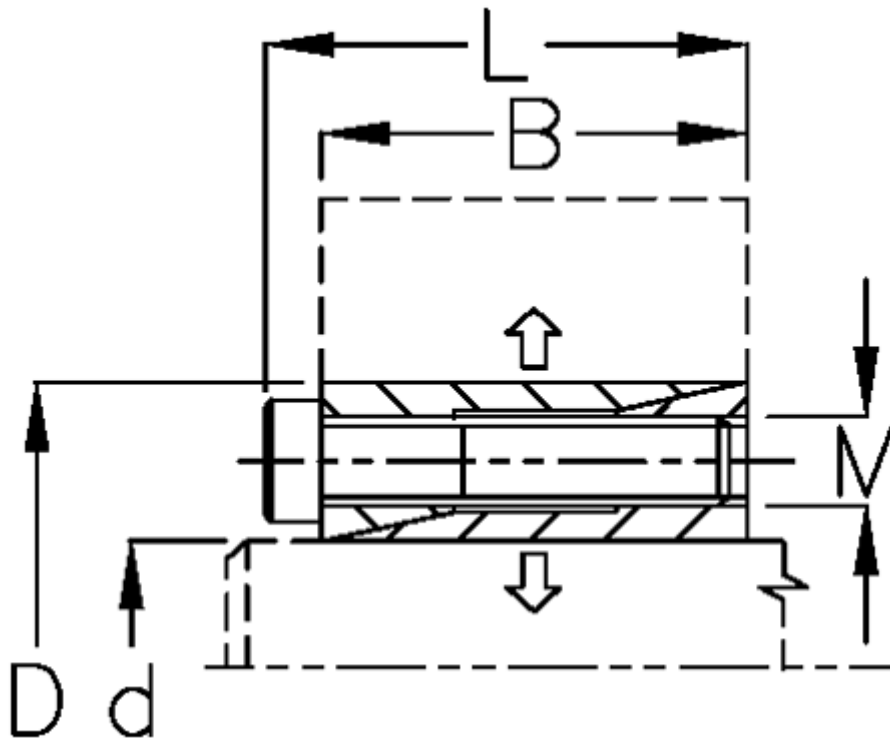

B mm	= 13
d mm	= 11.00
D mm	= 22
Fit tolerance	= Aksel h8, Nav H8
F kN torque	= 3.0
L mm	= 15.5
M mm	= M2,5
P N/mm ² surface pressure on shaft/hub	= 50

Surface roughness	= R? ? 3.2 µm
T N m torque	= 18
Ts N m bolt tightening torque	= 1.2